

User Manual 

**TRScONE**

**TRScONE R**

**TRScONE RR**

125 - 250 - 280 - 300



**TRSc**  
MOTORCYCLES



Welcome to TRS



Dear customer,

Thank you for your confidence in us, and congratulations on the purchase of your new TRS One.

Because of our experience, professionalism and passion for trial bikes we are able to offer you an innovative, reliable and up-to-date motorcycle. It has a comprehensively checked technical performance that has been tried and tested both by our technicians and our high-level drivers worldwide.

The solutions we have used give the motorcycle an unmistakable character, combining simplicity, reliability and design. We pay attention to every last detail to give you a unique bike.

At the same time, this manual gives you all the information you need to use the motorcycle appropriately and safely. We recommend that you read it carefully before you use the motorcycle.

In addition, you will find tips and useful information for the maintenance and upkeep your new TRS One.

Yours faithfully,

*Jordi Tarrés*



*Picture shows homologated version with regard to regulation (EU) N°168/2013*



*Picture shows competition version only and is not manufactured for, nor should it be used on public streets, roads or highways. The use of this kit should be limited to participation in sanctioned competition events upon a closed course.*

TRS advises you:

Please read this user manual thoroughly before using your motorcycle. It details all the instructions for the correct handling of the motorcycle and for your safety, as well as helping towards the best possible maintenance –and upkeep from day one.

Please pay special attention to the notes flagged up with the following symbols:



**ATTENTION!** This symbol refers to points which, if ignored, could lead to some kind of damage to your motorcycle. Non-observance of these warnings could render your motorcycle warranty void.



**CAUTION!** This symbol refers to points which, if ignored, could lead to physical danger for the user.



In addition to these specific warnings, the manual gives advice on the best use of your motorcycle, as well as better adjustment and control of its important features.

TRS reserves the right to make changes to this manual.

TRS recommends:

If you have any doubts about adjustments to your motorcycle, refer to the manual and/or contact an authorised TRS dealer.

Please carefully read through the information in the user manual to familiarise yourself with the features of your motorcycle before driving it using the maximum power settings.

- A running-in period of at least 8-10 hours without driving at high speeds or full throttle is advised, in order to allow the engine to bed in. In these first hours, drive at a moderate speed only.

- Fuel is a highly inflammable liquid. Use caution when refuelling and always turn off the engine first.

- Before running the engine at high speed, it is important to let it reach an optimum operating temperature, especially when starting up the motorcycle or in low temperature conditions.

- This motorcycle uses two-stroke synthetic oil mixed with 1% 98 octane fuel. Do not use any other kind of lubrication without previously checking with an authorised TRS mechanic.

- This motorcycle is designed to carry just one person, and it is not permitted to carry a passenger.

- For a long life of service, keep the motorcycle maintained as recommended in this manual.

- This bike is designed to be safe when driving, provided that the driver is equipped with the appropriate safety equipment (helmet, protective clothing, etc.). Be careful and drive sensibly.



<i>Index</i>	7	<i>22 - Temperature switch</i>	22
<i>1 - Description of parts</i>	8	<i>23 - Filling with coolant</i>	23
<i>2 - Technical specifications TRS One - Engine</i>	10	<i>24 - Bleeding air in the cooling system</i>	23
<i>3 - Technical specifications TRS One - Frame</i>	11	<i>25 - Carburettor</i>	24
<i>4 - Manufacturer's plate (under the fuel tank)</i>	12	<i>26 - Carburation of the mixture</i>	24
<i>5 - Starting and stopping the engine</i>	13	<i>27 - Ajuste del Ralenti</i>	24
<i>6 - Choke</i>	13	<i>28 - Front suspension</i>	25
<i>7 - Gearshift</i>	14	<i>29 - Rear suspension</i>	25
<i>8 - Fuel tap</i>	14	<i>30 - Drive chain</i>	26
<i>9 - Fuel tank</i>	15	<i>31 - Reed valve</i>	27
<i>10 - Tyres</i>	16	<i>32 - Swing arm</i>	27
<i>11 - Braking system</i>	17	<i>33 - Rear brake pedal</i>	27
<i>12 - Steering lock</i>	18	<i>34 - Footrest</i>	28
<i>13 - Side stand</i>	18	<i>35 - Exhaust muffler</i>	28
<i>14 - Handlebar and Instrument panel</i>	19	<i>36 - Tank clutch pump</i>	28
<i>15 - Adjustment of the levers and the handlebar</i>	20	<i>37 - Motorcycle maintenance</i>	29
<i>16 - Checking the oil level</i>	20	<i>38 - Pares de Apriete</i>	29
<i>17 - Changing the transmission oil</i>	20	<i>39 - Storage</i>	30
<i>18 - Spark plug</i>	21	<i>40 - Maintenance operations</i>	31
<i>19 - Air Filter</i>	21	<i>41 - Approval</i>	33
<i>20 - Cooling system</i>	22	<i>42 - Xtrack Kit</i>	34
<i>21 - Draining of coolant</i>	22	<i>43 - Troubleshooting and Frequently Asked Questions</i>	35
		<i>44 - Recommended products</i>	39

1 - Description of parts



- 1- Clutch lever
- 2- Indicator, horn and stop buttons
- 3- Brake lever
- 4- Accelerator
- 5- Radiator cap
- 6 - Fuel tank cap

- 7- Starter knob
- 8- Fuel tank
- 9- Radiator
- 10- Radiator bleed screw
- 11- Rear brake pedal

- 12- Engine breather
- 13- Fuel tap
- 14- Reed valve
- 15- Drive chain
- 16- Gear change pedal



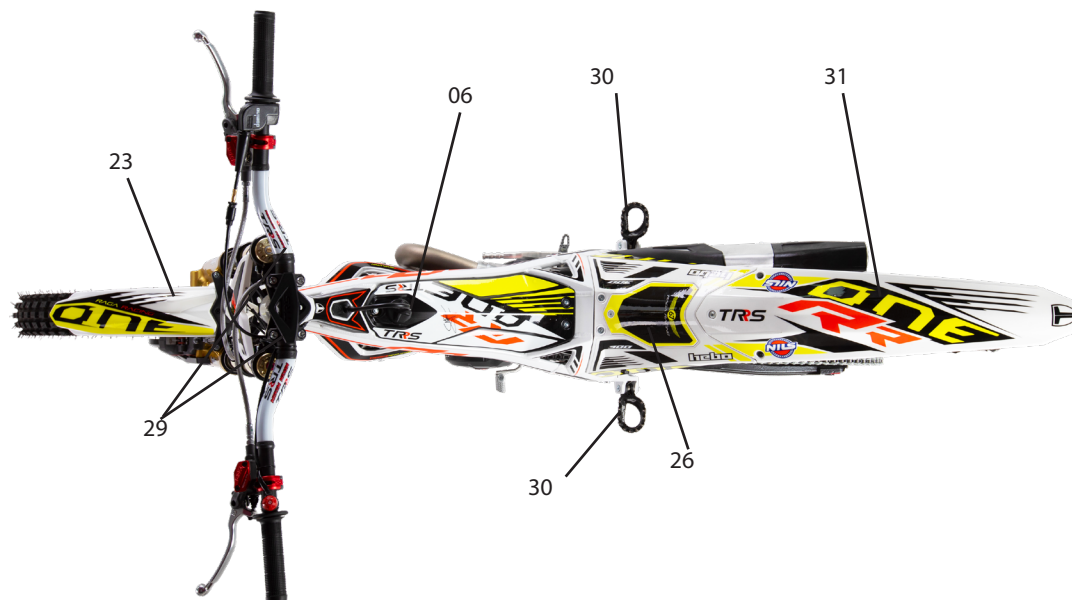

- 17- Front fork
- 18- Spark plug
- 19 - Exhaust muffler
- 20- Swing arm
- 21- Exhaust pipe

- 22 - Water pump
- 23- Front mudguard
- 24 - Front brake calliper
- 25- Ignition cover
- 26 - Air filter cover

- 27- Carburettor
- 28 - Sprocket
- 29 - Front suspension adjustment
- 30- Footrests
- 31- Rear mudguard

## 2 - Technical specifications TRS One - Engine

### Technical Specifications TRS One - Engine

ENGINE:	Single cylinder 2 stroke.
Displacement:	294,1cc - 272,2 cc - 247,7 cc
Cooling system:	Liquid cooled.
Bore x stroke:	79x60 mm (300 cc) - 76x60 mm (280 cc) - 72,5x60 mm (250 cc).
Ignition:	New HIDRIA CDI (double spark).
Clutch:	3 disks diaphragm TRS hydraulic system.
Gearbox:	5 speeds.
Engine oil capacity:	NILS TX FOR CLUTCH 350cc.
Transmission:	Chain.
Fuel:	Petrol 2.3L 98 2T oil 1.0%.
Carburettor:	Dellorto PHBL26 reed valve admission.
Starting:	Kick to primary transmission (kick-start).
Air filter:	Foam.
Spark:	NGK-R BPMR6A.

### 3 - Technical specifications TRS One - Frame

#### Technical specifications TRS One - Frame

CHASSIS:	Twin spar forged aluminium frame.
Swing arm:	Aluminium.
Front suspension:	Aluminium Tech, 39mm diameter, 175mm str.
Setting:	Adjustable spring extension and preload.
Rear suspension:	Progressive R16V hydraulic system
Front:	Spring preload and extension.
Stroke-travel:	Rear wheel stroke 168mm.
Wheel:	Morad aluminium radiated wheel.
Front-wheel tyre:	Chain 1.6x21 Michelin X11 Trial 2.75x21.
Rear-wheel tyre:	2.15x18 Michelin X11 Trial 4.00x18 TL.
Front brake:	Disc 185mm clamp 4 pistons BRAKTEC.
Rear brake:	Disk 150mm clamp 2 pistons BRAKTEC.
Net weight:	65Kg.
Dimensions:	Length x width x height: 2,015 x 830 x 1,125mm.
Seat height:	640mm
Engine Protector:	Aluminium 7075.
Foot rest:	Adjustable.

TRS Motorcycles recommend NILS lubricant.

4 - Manufacturer's plate (under the fuel tank)

All motorcycles manufactured by TRS have an identification number stamped on the frame which also appears in the technical sheet of the documentation that will be supplied to the user. This number cannot be replaced or changed. It is stamped on the tube on the right hand side of the frame and may be required in any technical inspection.

**SERIAL NUMBER AND KEY CODE**

These numbers are the ones that identify your motorcycle and the steering lock. Keep a note of them in your manual (e.g. to obtain a copy of the keys if they are lost).



We recommend that you keep a note of the serial number and the identification details for your motorcycle to use in the event of theft or to order spare parts.

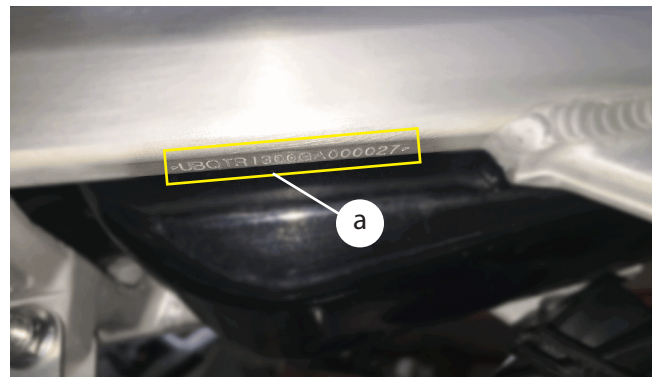

a) The position of the identification number, located on the tube on the right hand side of the frame.

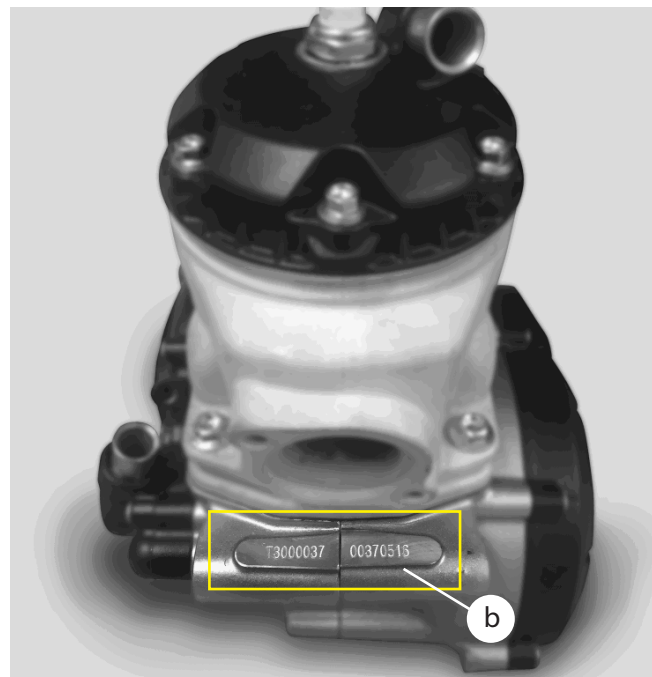

b) The engine identification number, located under the reed valve of the carburettor.

## STARTING AND STOPPING THE ENGINE



a) Start lever, on the right side of the TRS One



b) Stop button, to the left of the handlebar

The Stop button is positioned on the left-hand side of the handlebar, close to your thumb for easy use.



c) Racing light button, behind the headlight

## CHOKE

Use the choke when the engine is cold to help starting without damaging the engine. This device, used correctly, will prevent wear and mechanical damage by starting the motorcycle in adverse temperatures. It is operated by a black lever located in the carburettor.

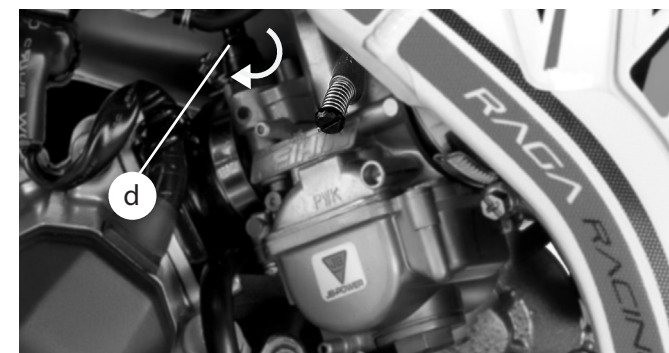
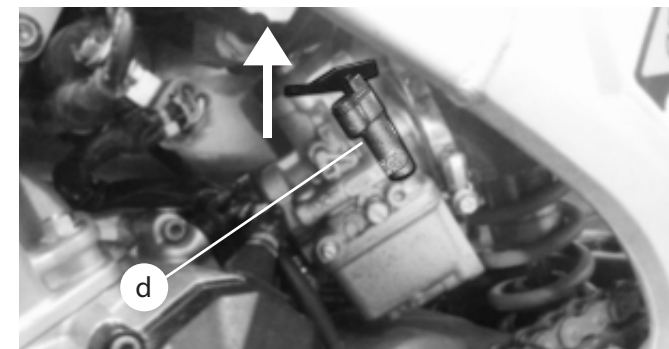

d) Choke, in the carburettor

## GEARSHIFT

The gearshift is controlled by a pedal on the left-hand side of the vehicle. The sequence of gears is as shown in the diagram. You must hold down the clutch lever on the left while changing gear. The position of the gears is illustrated in the diagram.

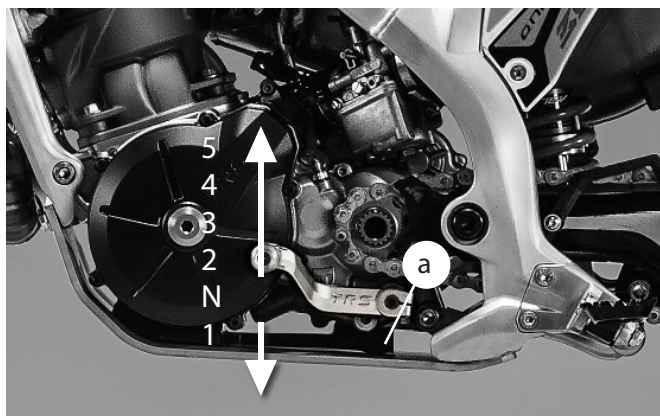

a) Gear shift lever

*You can find the first gear by pushing the lever downwards. For the other gears, push the lever upwards, moving up a gear each time you push it.*

## FUEL TAP

On the left side of the frame, you can see the diagram for using of the fuel tap.

The small operating lever is located above the carburettor.

We advise turning off the fuel tap when transporting the motorcycle in a vehicle as well as when it is not in use for a long period.

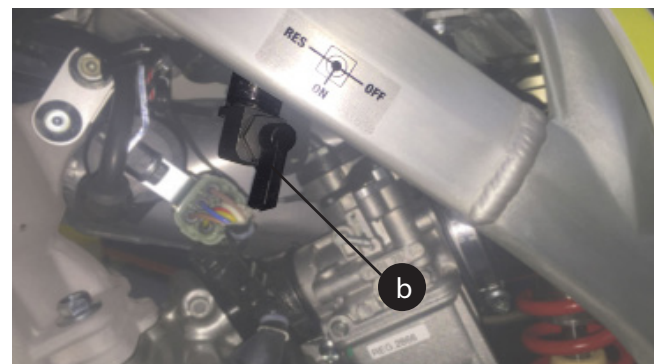

*Positions Res, On and Off in the fuel tap. There is a sticker on the frame showing the position.*

b) Fuel tap

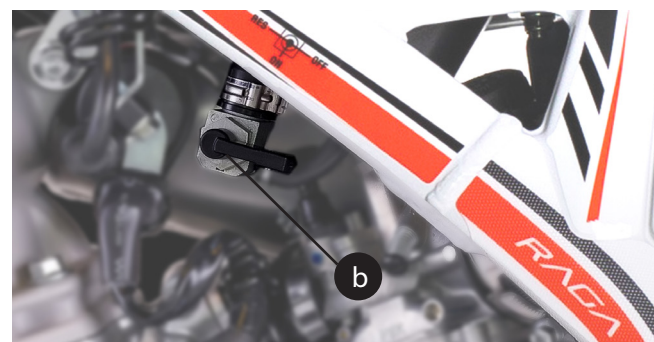

b) Fuel tap

## 9 - Fuel tank

### FUEL TANK

The tank has a capacity of 2.5 litres and should be filled with a mixture of unleaded petrol and oil. The tank cap is positioned at the top of the tank. Minimum octane rating of fuel: 98 octanes.



Important. Do not mix vegetable and mineral oil. Keep to the specified levels and proportions for correct combustion in the engine. To produce a uniform mixture, first pour the oil and part of the petrol into a container, shake and then add the rest of the petrol. It is more difficult to produce a good mixture at low temperatures and this should be avoided.

TYRES



TYRES

Front wheel:  
2,75x21" TRIAL  
Rear wheel:  
4,00x18" TRIAL

RECOMMENDED TYRE PRESSURE:

Front wheel:  
0,45bar (0,42bar for competition)  
Rear wheel:  
0,35bar (0,3bar for competition)

On low-grip terrain you can reduce the tyre pressure slightly to increase the grip and vice versa.



The condition of the tyres is a key factor in safety and guarantees better driving. Make sure your tyre pressure is always correct and check for wear. The pressure must be checked when the tyre is cold.

Image of the rear wheel of the TRS



# 11 - Braking system

## BRAKE PADS

To ensure optimal braking you need to check the condition of the brake pads. Initially the pad indicator groove is normally around 3mm. If after use you find this has been reduced to below 2mm, they need to be replaced.

To replace them you need to remove the brake calliper from the fork tube, taking out the bolts and the wire clip that you can remove from underneath. For reassembly you will need to lever the pistons back with a screwdriver. Then make sure the bolts and the wire pin clip are tight.

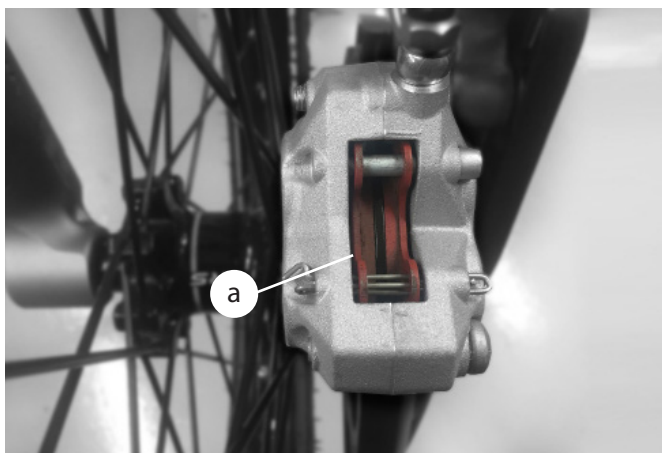

a) Brake pads

## LEVEL OF REAR BRAKE FLUID

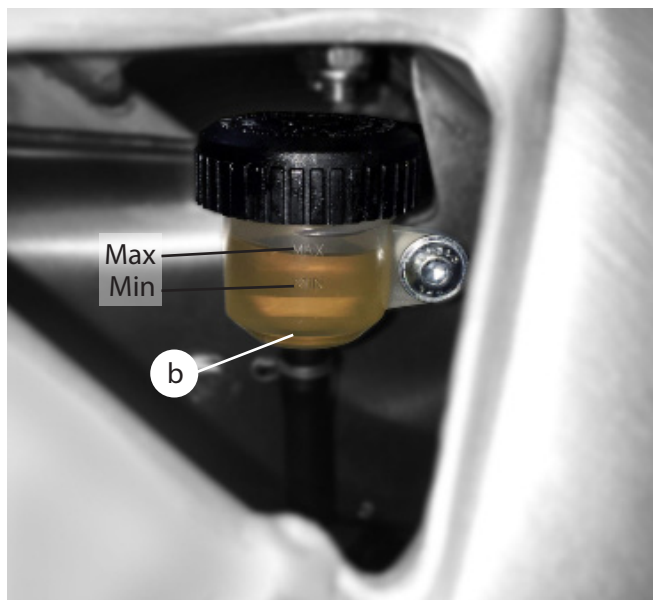

b) Rear brake reservoir

To check the rear brake fluid level, you can view it through the triangle of the frame on the left side of the motorcycle. The level needs to be kept between the minimum and the maximum. You can access the oil reservoir by removing the petrol tank and loosening the cap on the tank. Brake fluid is highly corrosive so avoid spillage.

## LEVEL OF FRONT BRAKE FLUID

At the rear of the front brake pump you can check the fluid level, and replenish it to the correct level with brake fluid NILS DOT-4.



c) Level of fluid in the front brake pump.

## STEERING LOCK SYSTEM

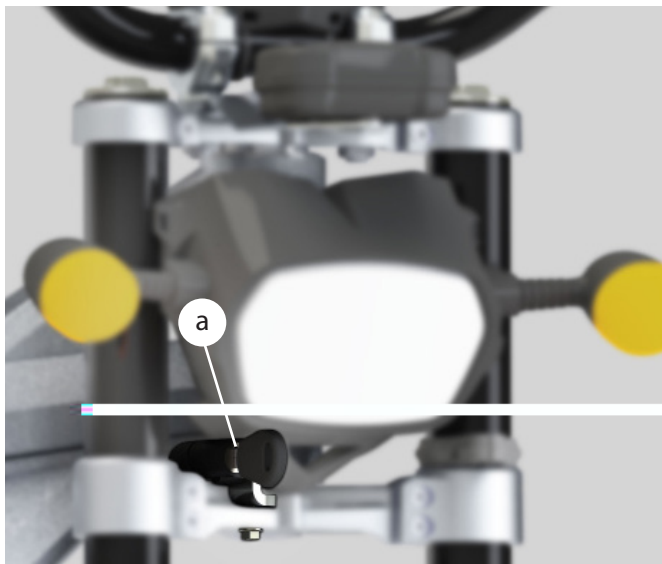

a) The steering lock system is located under the headlight

The anti-theft system located at the front of the motorcycle allows you to immobilise the steering. Turn the handlebars as far as they will go to the right and press the anti-theft system, turning the key until you feel it lock.

## SIDE STAND

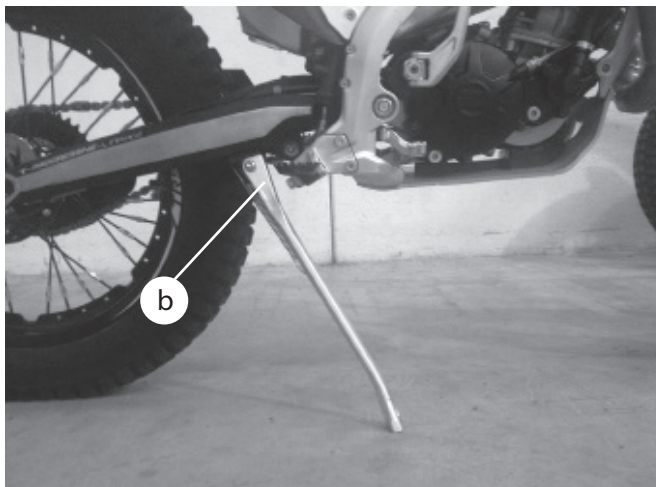

b) Side stand located on the right of the motorcycle

The side stand is located on the right side of the vehicle, secured to the frame by a spring. Move the side stand out as far as it will go to rest the motorcycle on it when stationary.

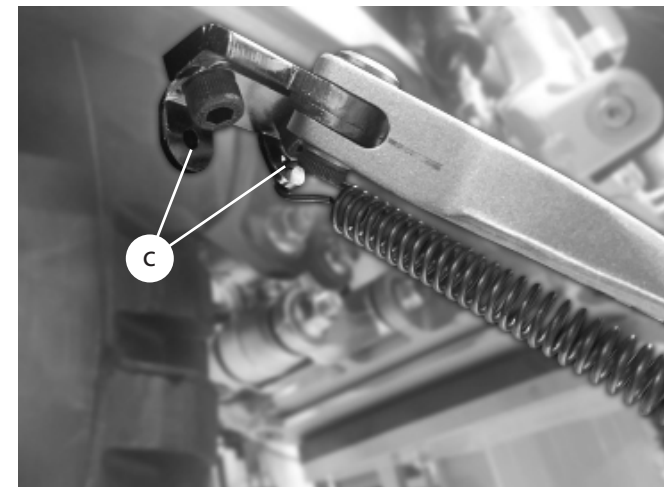

c) Adjustment holes in the side stand

At the base of the side stand there are two holes that you may use to change the way it folds up. If you put the spring in the forward setting in the direction of travel, the side stand will always stay open until you raise it. If you use this position, it is important to remember to manually lift it before starting off. Whereas if you put the spring into the rear setting, the stand will automatically fold up into position in order for you to drive.

## 14 - Handlebar and Instrument panel

### HANDLEBAR AND INSTRUMENT PANEL

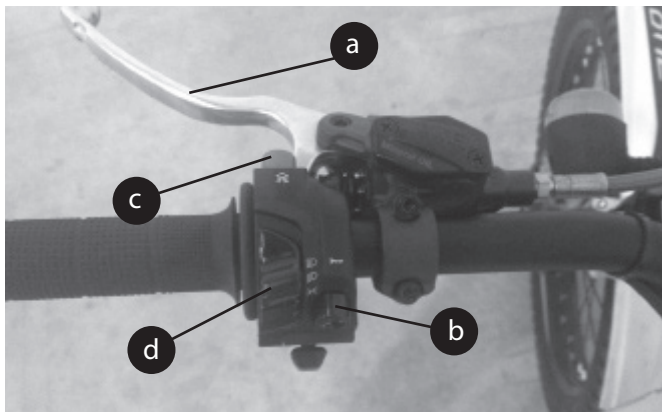

Left-hand side of the handlebar.

On the left side of the handlebar are:

- a) - Clutch lever.
- b) - Horn.
- c) - Engine stop button.
- d) - Main/dip beam switch, and indicator switch - (Motorcycle approval)



Central part of the handlebar.

The instrument panel is in the centre of the handlebar (e). (More information and instructions for use are given in later sections of this manual).



- f) At the back of the headlight is the CDI map switch. Here, you can choose between the positions:  
I: Wet or 0: Dry.

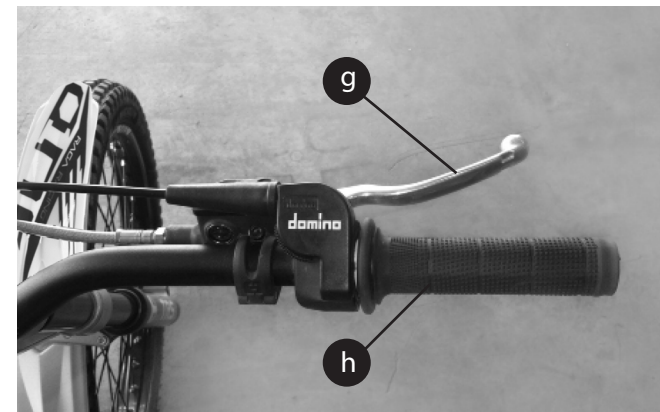

Right-hand side of the handlebar.

On the right-hand side of the handlebar you can find:

- f - Brake lever.
- g - Throttle.

### ADJUSTMENT OF THE LEVERS

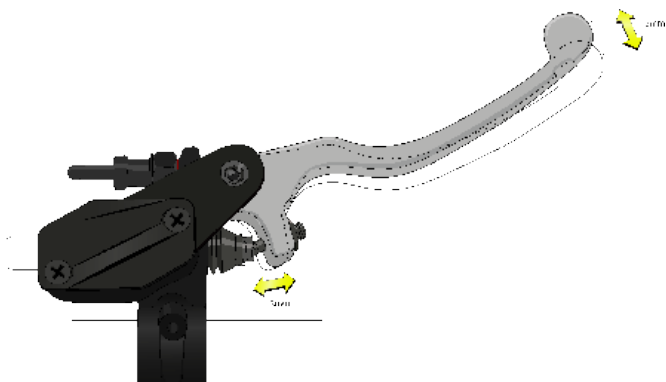

Maximum initial free play of both levers of the handlebar.

Both the clutch lever and the brake lever must have a maximum initial free play of 3mm. It is important that this free play exists and you should not disable it. To adjust, use the adjustment nuts on the levers.

To adapt the handlebar to different types of driving, you can change the angle by loosening the clamps that secure it to the fork. Once you have adjusted it as desired, tighten the bolts again, starting with those closest to the seat and moving on to those closest to the speedometer.

### CHANGING THE TRANSMISSION OIL

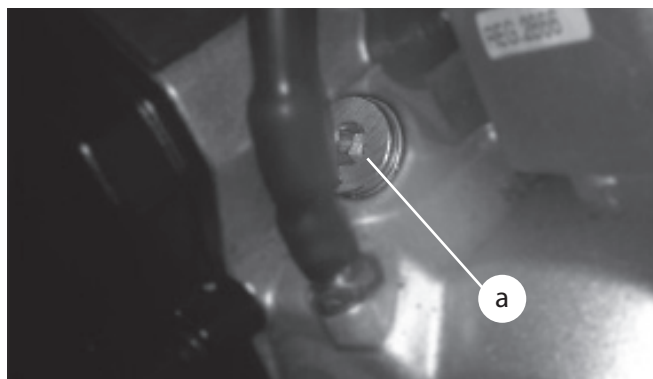

a) Oil filler cap, in the upper part of the sump.

The engine has a capacity of 350 cc of transmission oil.

Do not mix different types of oil. Always top up using the same type. We recommend using oil such as NILS CLUTCH TRIAL.

TRRS Motorcycles recommends NILS CLUTCH TRIAL.

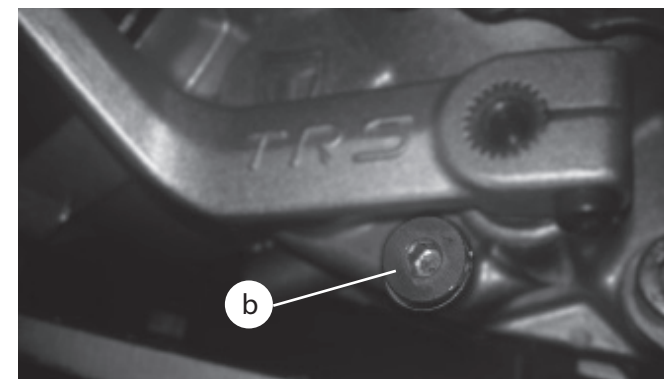

Fig (b): Oil drain plug at the bottom of the sump

There is a plug on the bottom of the sump for draining the oil Fig(b) and another in the upper part for filling Fig(a). To change the oil, start the motorcycle with a cold engine and let it run at idle speed for 5 minutes. This will warm up the oil to the right temperature for changing.

Then place the motorcycle in driving position with a container below and remove the drain plug. Let all of the oil drain out, and then clean the plug, removing any metal shavings. Once it is clean, replace it and refill the engine through the opening on the top, until reaching the desired level in the sight level glass.

## SPARK PLUG



a) The plug that is factory-installed is defined in the technical specifications. Tighten to 11Nm.

It is important to maintain the gap stipulated by TRS of 1mm between the electrode and the arc to ensure optimum engine performance. Its colour tells you whether you are using the right fuel:

Very white colour: very poor mixture.  
Very black colour: too greasy a mixture.



## AIR FILTER

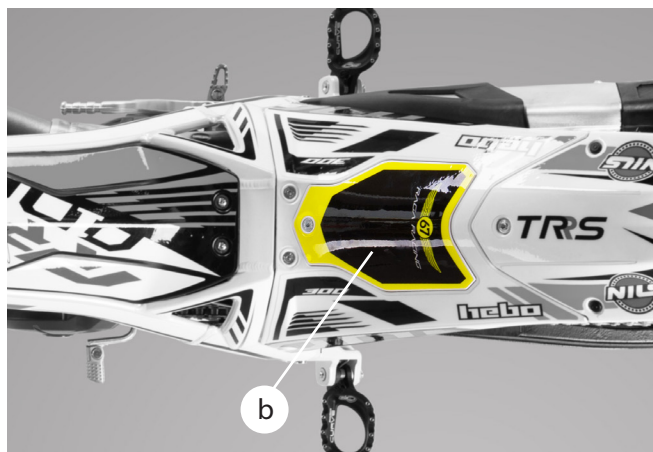

b) Top view of the cover of air filter case.

The air filter is easily reached removing the top hatch of the air filter case. Move the spring back in order to remove the filter for cleaning or replacement.

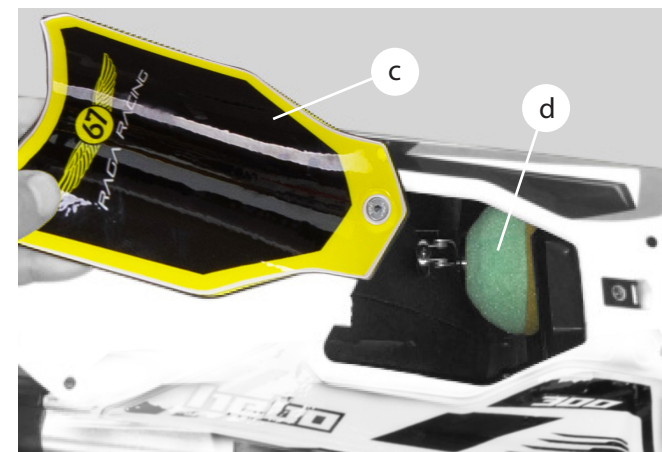

c) By removing the hatch you can easily reach the air filter to clean or replace it; d) Foam air filter.

It is very important to clean it after each time you remove it to ensure it functions correctly and to obtain the best performance from the engine without reducing its reliability. To insert it, slide through the centre of the spring to make sure it is placed correctly.

## COOLING SYSTEM



a) Radiator

Do not forget that the radiator can get very hot. When handling, be cautious and wait for it to cool down after stopping the engine. Always use coolant (-30°C) for light alloy engines for topping up the radiator.

The tubes into and out of the radiator should be regularly checked for dents, cracks or leaks that could impair the cooling system. For correct maintenance of the engine, make sure it has the right level of coolant. To do this, you can top up the radiator tank through the cap at the top (preferably with the recommended coolant).

## DRAINING OF COOLANT

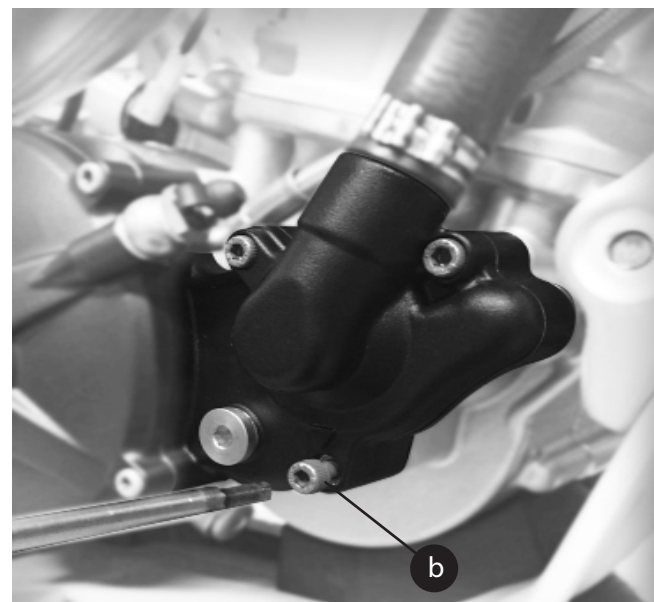

b) Coolant drain bolt located on the lid of the water pump.

By loosening the coolant drain bolt at the bottom of the water pump you can drain the coolant circuit of the engine.

It is important to wait until the engine is at ambient temperature to drain the radiator, to avoid any danger of burns.

## TEMPERATURE SWITCH

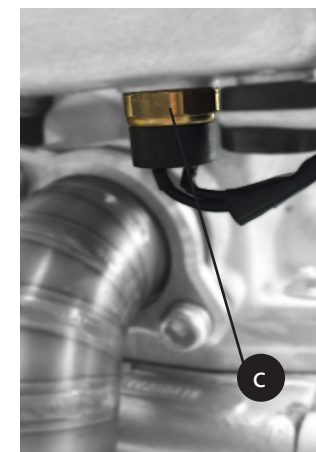

b) Temperature switch located at the bottom of the radiator.

The temperature switch controls the start and stop of the fan to ensure the engine has the correct operating temperature.

It is important to be aware if the motorcycle is overheating and the fan is not working. In this case, it needs to be replaced.

## FILLING WITH COOLANT

Remove the cap on the top of the radiator to fill it up with coolant, making sure you remove the air using the bleed screw on the cylinder head. For optimum functioning, do not fill the radiator right up to the top. We recommend using a suitable filling receptacle for greater control.



The factory-supplied coolant is a permanent-type antifreeze of ethylene glycol, diluted in 50% distilled water and containing anticorrosive additives.

We recommend periodically bleeding the system and changing the coolant. Watch out for abnormal colour of the coolant: white stains (corroded aluminium), brown stains (corroded steel). To respect the environment, dispose of the used coolant in the designated places.

a) Filler cap located on the top of the radiator.

## BLEEDING AIR IN THE COOLING SYSTEM

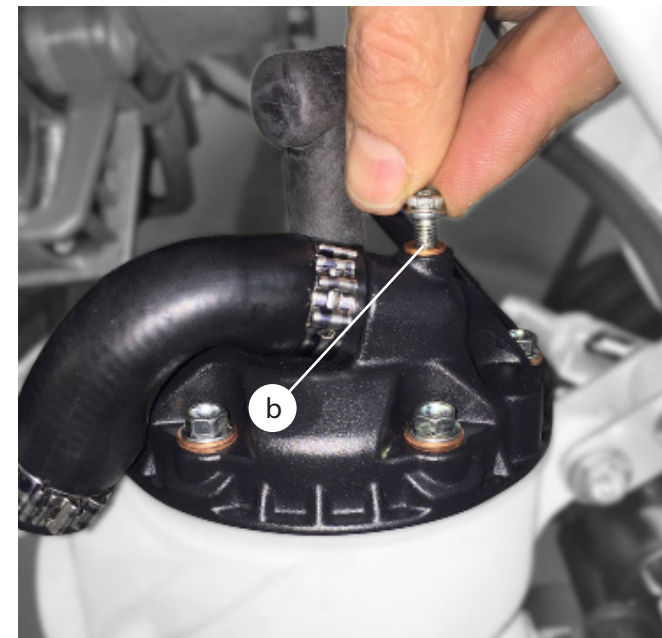

b) Bleed screw for the coolant, located in the cylinder head.

In order to ensure that the cooling circuit is fully bled, when you are filling it with coolant, loosen the screw located at the top of the cylinder head until the air has been released, and retighten it. Then fill the radiator up to the correct level, not quite full, so that the air acts as an expansion vessel.

## CARBURETTOR

It is advisable to periodically check the carburettor, washing and drying it with compressed air to improve its performance. Check the height of the float that marks the level of fuel in the carburettor and adjust it so it is at 17mm within the specified margins.



a) Carburettor. When handling the carburettor and adjacent parts there may be traces of fuel that need to be drained first.

Be cautious: fuel is highly flammable and toxic.



## CARBURETION OF THE MIXTURE

An optimum petrol-air mixture will enable you to obtain maximum performance from your engine. To do this, you need to adjust the amounts of fuel and air entering the carburettor.

A good way to find out the quality of the mixture that is going into the engine is to inspect the spark plug. If the plug is light brown in colour, the mixture is good, whereas if it is black (excess of petrol), or white (excess of air), the mixture reaching the engine is wrong.

To control the amount of fuel reaching the engine you can adjust the position of the main jet, which has a graduated scale, where the higher the number indicates the greater the flow of fuel. You can also control the mixture by adjusting the air screw, unscrewing it to enrich the mixture and vice versa.

## ADJUSTMENT OF THE IDLE SPEED

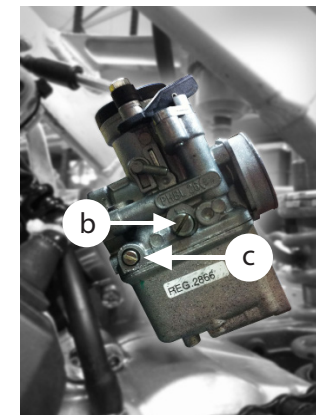

b) Idle speed c) Air

The carburettor has two adjustment screws: the air screw and the idle speed screw, which allow you to change the speed of operation if you so require.



## FRONT SUSPENSION



a) Spring preload; b) Adjusting the length



a) On the right-hand side of the suspension you can set the preload.



b) On the left-hand side of the suspension you can set the length.

The front fork can be adjusted with the screws at the top

To adjust the preload, turn the screw on the left-hand fork tube, and to set the length, turn the screw on the right-hand tube.

## REAR SUSPENSION

For correct functioning of the motorcycle, it is very important to fit the suspension wishbone arm in its original position. Its asymmetric triangle shape allows you to make sure that it is correctly positioned. Once it is in place it should be tilted slightly upwards.

The maintenance and lubrication of the bearings, seals and ball joints of the system is essential to guarantee smooth operation, in addition to ensuring that the screws are correctly tightened.

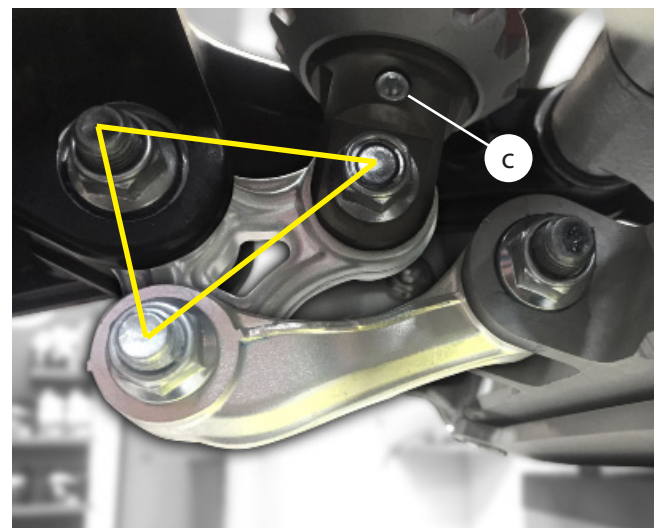

c) The hydraulic brake of the shock absorber can be adjusted using the screw located on the bottom.

Important! It is essential to maintain and lubricate the bearings, ball joint and seals.

## 30 - Drive chain

### DRIVE CHAIN

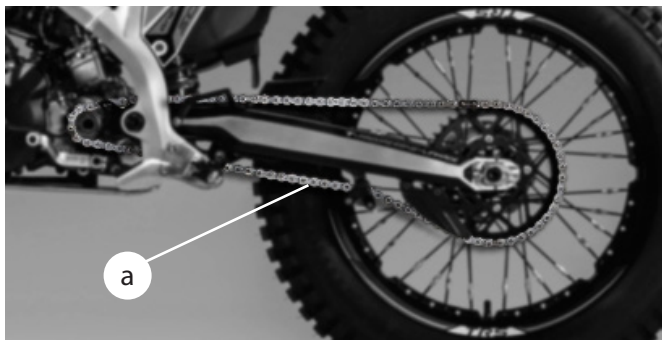

a) Drive chain

The drive chain slack adjusting bolt is located on the sides of the swinging arm. Using the adjusting bolt you can obtain the right chain slack, making sure to adjust both sides evenly for correct wheel alignment.

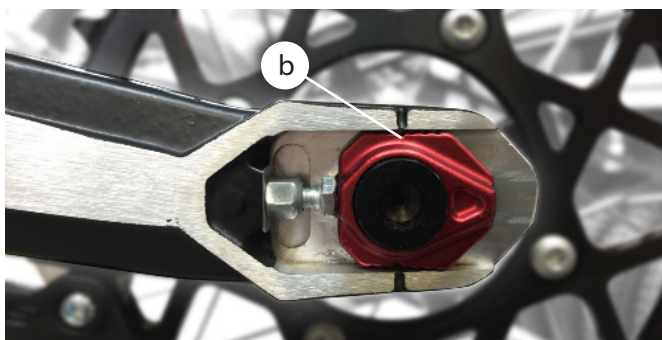

It is important to assemble the connecting link carefully. The closed end must point in the direction of chain rotation so that it doesn't fly off if the chain is hit by a stone. Also, keeping the chain clean and lubricated prolongs the life of the drive pinion and sprocket. After the chain has been tightened multiple times, it will need to be replaced.



c) Connecting link.

b) Once you have adjusted the chain to the right tension, tighten up the axle.

The tension of the chain should allow a play of approximately 10-15mm in the area between the swinging arm and the slack adjusting bolt.

To tighten the chain, first loosen the rear axle nut and then adjust the chain with the drive chain slack adjusting bolt located on the swing arm. When adjusted, tighten the nut on the rear axle, making sure that the chain is aligned and not twisted.

You need to carry out this adjustment with care, as a rear wheel axle that is misaligned or has a screw not tightened sufficiently could cause an accident.

Keep the chain lubricated for smooth operation, preferably using viscous oil for longer life. It is also important to lubricate the shaft and the nut.

## REED VALVE

The inlet is through a reed valve and its condition has a significant influence on the performance of the engine. Whenever the carburettor is removed for cleaning, make sure the reed valves are not worn or broken and if so, replace the valve with a new one.

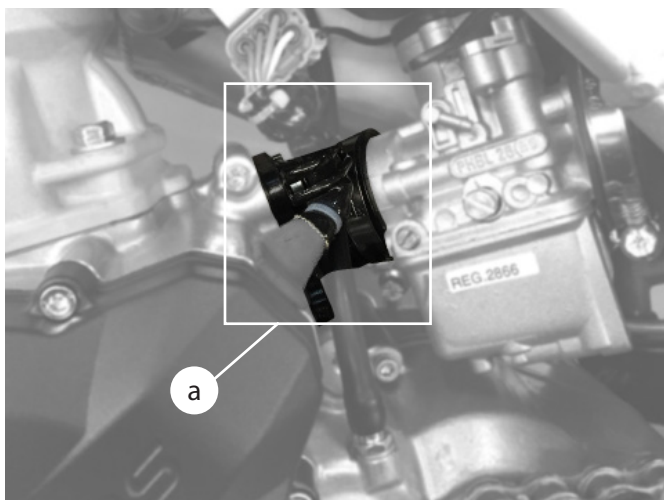

a) Reed valve, located between the carburettor and the engine.

## SWING ARM

For correct maintenance of the rear suspension system and swing arm, it needs to be regularly dismantled for cleaning, checking and lubricating the internal bearings, plus adjusting and lubricating of the chain. Make sure that all the parts are in perfect condition and replace any worn components as required.

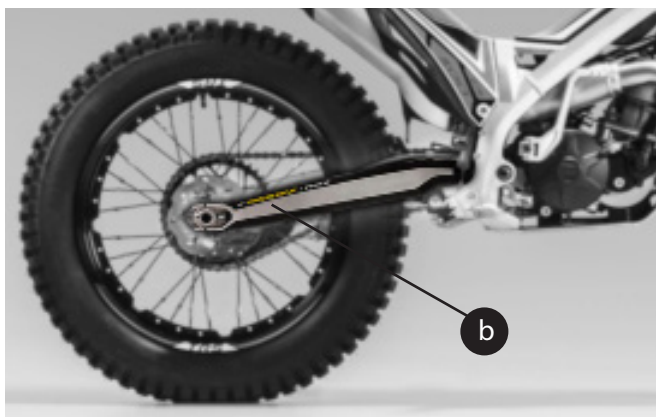

b) Important! The swing arm and the rear suspension need to be regularly maintained.

## REAR BRAKE PEDAL

The screw for adjusting the brake pedal height in relation to the footrest is at the front of the lever.

At the rear there is a rod and lock nut that allow you to adjust the rear brake. It is very important that when it has been tightened there is 2mm clearance gap at the front to ensure smooth operation.

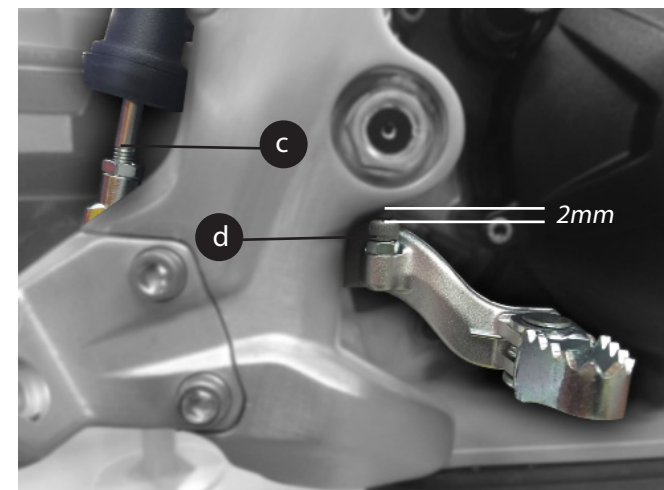

c) Tensioning rod rear brake pedal; (d) Screw for height adjustment of the brake pedal. For correct performance, you need to leave a small clearance gap.

## FOOTRESTS

The footrests are adjustable. By swapping the washers you can move them forward or backwards from 2.5mm to 5.00mm.

This allows you to customise the motorcycle for greater efficiency and comfort, depending on your height or driving style.

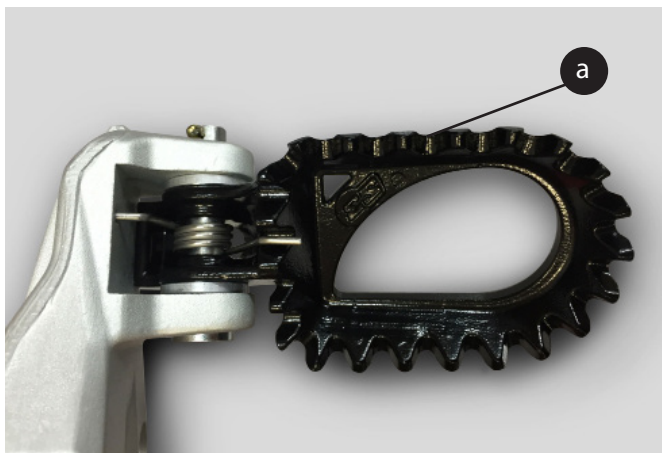

a) The footrests are adjustable, so that you can move them forwards or backwards by moving the washers 2.5mm to 5.00mm in either direction.

## EXHAUST MUFFLER

The end of the muffler is detachable and allows you to easily replace the exhaust packing fibreglass in order to improve the performance of the motorcycle.



b) ) Important! Remember that when the motorcycle is turned on, the exhaust get very hot.

## CLUTCH PUMP TANK

It is necessary to periodically check the oil level in the clutch pump tank. As is indicated on the lid, only mineral oil may be used, in order not to damage the o-rings.

We recommend NILS mineral oil. If you need to bleed the circuit, push down the lever repeatedly until you note it has been bled, and then fill with oil up to 2mm from the top.



c) Clutch pump tank. Only mineral oil may be used, in order not to damage the o-rings

## MOTORCYCLE MAINTENANCE

The greater the care given to the motorcycle, the longer its service life will be and the better it will perform. Check all the elements listed below and keep them clean and lubricated for optimum service:

·LEVER ARTICULATIONS

·REAR BRAKE PEDAL

·GEAR LEVER

·FOOTRESTS AND SIDE STAND

·STARTER PEDAL

·THROTTLE

·STEERING COLUMN

·DRIVE CHAIN AND SWING ARM ARTICULATIONS

·CHAIN TENSIONER

## TIGHTENING TORQUES

TORQUE	Nm
Swinging arm-Chassis	40-50
Upper shock absorber fastener	40-50
Lower shock absorber fastener	40-50
Front wheel axle	40-50
Connecting rods	40-50
Handlebar	25-30
Front mudguard bridge	7-10
Muffler	10-15
Rear wheel axle	40-50
Front brake calliper fasteners	25-30
Exhaust pipe fasteners	10-15
Engine fasteners	30-35
Rear brake master cylinder fasteners	7-10
Spark plug	11

TORQUE	Nm
Ignition fasteners	7-8
Clutch fasteners	20-25
Cylinder stud fasteners	25
Reed valve fasteners	7-8
Clutch spring fasteners	3-4
Sump fasteners	7-8
Water pump cover fastener	7-8
Clutch cover fasteners	7-8
Flywheel fasteners	40
Ignition cover	7-8
Sump drain plug	12
Starter pedal bolt	12-13
Tornillo del pedal de cambio	7-8
Gear change pedal bolt	12-13

## STORAGE

If it is necessary to store the motorcycle for a long period of time, the following operations are recommended before storage:

- Clean the whole vehicle.
- Lubricate or grease the components that need it.
- Empty the fuel tank. (Take care with the fuel, which is inflammable and toxic)
- Empty the sump, removing the old transmission oil and refilling with new oil (If the engine is cold, it is recommended to start up and leave running for a few minutes to warm up the oil and assist draining).
- Cover the exhaust with a plastic bag, protecting it from the elements.
- Any unpainted metal parts that could get rusty should be coated with oil.
- Avoid the tyres touching the ground by placing a piece of cardboard or similar material under them.
- Protect the motorcycle as much as possible from dust and dirt by covering it with a plastic or canvas sheet.

When putting the motorcycle back into service, first:

- Remove the plastic covers used.*
- Check the oil and lubrication of components.*
- Check the spark plug.*
- Adjust tyre pressure as recommended.*
- Fill the petrol tank.*



## 40 - Maintenance operations

### MAINTENANCE WORK

(Note: Note that cleaning your motorcycle prior to maintenance will aid you in detecting any faults and wear in the vehicle)

COMPONENT	CHECK	ADJUST	REPLACE	CLEAN	LUBRICATE
Rear shock absorber	Annually		Every 2 years		
Front fork suspension oil			60 hours		
Transmission oil	2 hours		10 hours		
Brake adjustment	After every use	Whenever necessary			
Spark plug	10 hours	30 hours	60 hours	15 hours	
Swinging arm and connecting rods	After every use		If damaged	After every use	After each wash
Transmission chain	After every use	Whenever necessary	If damaged	After every use	After each wash
Throttle cable and twist grip	After every use	Whenever necessary	If damaged	Whenever necessary	After each wash
Reed valve box	30 hours		If damaged	After every use	
Carburettor		Whenever necessary	If damaged	After every use	
Chassis			If damaged	After every use	
Carburettor jet		Whenever necessary	If damaged	10 hours	
Steering bearing			If damaged		
Piston bearing			If damaged		
Wheel bearing			If damaged		
Engine bearings			If damaged		
Rear sprocket	30 hours	First 5 hours	If damaged		After each wash
Cylinder head and cylinder	60 hours		Annually		
Brakes	After every use	Whenever necessary	If damaged		
Brake discs	After every use	First 5 hours	If damaged	Each two uses	
Clutch plates			If damaged		
Clutch			If damaged		
Wheel-muffler clearance	After every use		If there are any fall		
Exhaust			500 hours		
Muffler exhaust packing fibreglass			100 hours		

COMPONENT	CHECK	ADJUST	REPLACE	CLEAN	LUBRICATE
Air Filter	After every use		If damaged	After every use	After each wash
Steering play	After every use	Whenever necessary			
Brake hoses		Whenever necessary	Every 2 years		After each wash
Coolant		Whenever necessary	Annually		
General lubrication	After every use			After every use	After each wash
Front and rear wheel			If damaged	After every use	
Tyres	After every use		If damaged	After every use	
Brake fluid level		Whenever necessary			
Chain guide slipper			If damaged		
Starter pedal and gear change pedal			If damaged		After each wash
Brake master cylinder piston and dust cover			If damaged		
Brake piston and dust cover			In the event of a fall		
Piston and rings	60 hours		Annually		

Front and rear wheels	20 hours		If damaged	After every use	
Fuel system	After every use		If damaged		
Front suspension		Whenever necessary	If damaged		
Exhaust seal			If damaged		
Nuts, bolts and other fasteners		Whenever necessary	If damaged		
Petrol tube	After every use	Whenever necessary	If damaged		
Radiator tube and joints	After every use	Whenever necessary	If damaged		
Chassis protective adhesive elements			If damaged		
Sump protector			If damaged		



## APPROVAL

All the components fitted in this vehicle comply with legal approval requirements, including the identification marks on parts that require them.

In particular, note that the following items are compulsory for using the motorcycle on public roads and must be present on the vehicle in order to pass the Vehicle Technical Inspection Test:

- Registration plate holder
- Speedometer
- Lighting system and reflectors
- Indicators
- Horn
- Rear view mirrors
- Steering lock
- Manufacturer's identification plate
- Air filter restrictor
- Exhaust system with catalyser
- Exhaust muffler
- Carburettor jets
- Side stand

**IMPORTANT NOTE:** The vehicle is also supplied with a RACING KIT containing additional components. Bear in mind that the modifications provided by this kit are NOT covered by the vehicle approval.



42 - Xtrack Kit

XTRACK KIT

This kit is a competition accessory only and is not manufactured for, nor should it be used on public streets, roads or highways. The use of this kit should be limited to participation in sanctioned competition events upon a closed course.



## 43 - Troubleshooting and Frequently Asked Questions

### TROUBLESHOOTING: FREQUENTLY ASKED QUESTIONS

(IMPORTANT NOTE: We recommend you go to an authorised garage to carry out any internal adjustments to the engine or parts that are not the result of normal wear. Please note that tampering with the motorcycle is potentially dangerous to you and/or may lead to possible cancellation of the warranty)

PROBLEM	POSSIBLE CAUSES	STEPS TO TAKE
The engine won't start	<ul style="list-style-type: none"> <li>- Dirty spark plug.</li> <li>- Engine flooded.</li>   <li>- Fuel badly mixed.</li> </ul>	<ul style="list-style-type: none"> <li>- Clean and dry the spark plug or change it.</li> <li>- Open the throttle fully and kick the starter pedal 5 to 10 times and then start the engine.</li> <li>- Check for obstruction in the petrol tank tubes and air filter.</li> </ul>
The engine starts correctly and then stops	<ul style="list-style-type: none"> <li>- Incorrect air supply, engine flooded.</li> <li>- Insufficient fuel.</li> </ul>	<ul style="list-style-type: none"> <li>- Close the choke, check the fuel pipes.</li> <li>- Fill the fuel tank.</li> </ul>
Engine overheated	<ul style="list-style-type: none"> <li>- Coolant running low.</li> <li>- Radiator dirty or obstructed.</li> </ul>	<ul style="list-style-type: none"> <li>- Add coolant, check for possible leaks.</li> <li>- Clean the radiator fins.</li> </ul>
Engine runs erratically	<ul style="list-style-type: none"> <li>- Problems with the spark plug and/or plug cap.</li> <li>- Fault in the ignition rotor.</li> <li>- Water in the fuel.</li> </ul>	<ul style="list-style-type: none"> <li>- Check the condition of both.</li> <li>- Change the rotor.</li> <li>- Empty the tank and refill with new petrol.</li> </ul>

PROBLEM	POSSIBLE CAUSES	STEPS TO TAKE
Engine makes strange noises	<ul style="list-style-type: none"> <li>- Ignition problems.</li> <li>- Overheated engine.</li> </ul>	<ul style="list-style-type: none"> <li>- Take the motorcycle to an authorised workshop.</li> <li>- Stop the engine and check the state of the cooling and exhaust systems.</li> </ul>
Engine lacks power	<ul style="list-style-type: none"> <li>- Intake problems.</li> <li>- Exhaust system problems.</li> <li>- Carburettor jets dirty.</li> <li>- Damaged crankshaft bearings.</li> <li>- Clutch slipping.</li> </ul>	<ul style="list-style-type: none"> <li>- Clean the fuel admission system and air filter.</li> <li>- Check for leaks in the system and clean or replace the exhaust packing fiberglass.</li> <li>- Remove the carburettor and clean it.</li> <li>- Replace the bearings.</li> <li>- Check its adjustments. Take bike to a specialist garage.</li> </ul>
Exhaust gives off white smoke	<ul style="list-style-type: none"> <li>- Water is getting into the cylinder.</li> <li>- Accelerator cable incorrectly adjusted.</li> </ul>	<ul style="list-style-type: none"> <li>- Change the cylinder head O-ring.</li> <li>- Check accelerator adjustment.</li> </ul>
Exhaust gives off brown smoke	<ul style="list-style-type: none"> <li>- Insufficient air in the mixture.</li> <li>- Main jet too high.</li> </ul>	<ul style="list-style-type: none"> <li>- Clean or change the air filter.</li> <li>- Check the main jet</li> </ul>
Explosions in the exhaust	<ul style="list-style-type: none"> <li>- Carbon deposits in the combustion chamber.</li> <li>- Incorrect type of fuel.</li> <li>- Spark plug in bad condition or wrong type.</li> <li>- Exhaust system gaskets damaged.</li> </ul>	<ul style="list-style-type: none"> <li>- Clean the combustion chamber.</li> <li>- Empty fuel tank and refill with correct type of fuel.</li> <li>- Replace spark plug with correct type.</li> <li>- Check condition of gaskets and replace if necessary.</li> </ul>
Clutch not working correctly	<ul style="list-style-type: none"> <li>- No play in the clutch lever.</li> <li>- Clutch worn.</li> <li>- Clutch springs broken or weak.</li> </ul>	<ul style="list-style-type: none"> <li>- Take bike to a specialist garage.</li> </ul>

PROBLEM	POSSIBLE CAUSES	STEPS TO TAKE
Gears engage badly	<ul style="list-style-type: none"> <li>- Problems in forks, gears or additional gearbox systems.</li> </ul>	<ul style="list-style-type: none"> <li>- Take bike to a specialist garage.</li> </ul>
Abnormal noises	<ul style="list-style-type: none"> <li>- Worn or badly adjusted chain</li> <li>- Rear sprocket teeth worn.</li> <li>- Chain needs lubrication.</li> <li>- Badly aligned rear wheel.</li> <li>- Lack of oil in the front fork.</li> <li>- Problems with the front fork springs.</li> <li>- Worn brake disc.</li> <li>- Brake pads glazed or badly fitted.</li> </ul>	<ul style="list-style-type: none"> <li>- Adjust or change chain.</li> <li>- Change rear sprocket.</li> <li>- Apply appropriate chain lubricant.</li> <li>- Take bike to a specialist garage.</li> <li>- Add fork oil to the specified level.</li> <li>- Replace front fork spring.</li> <li>- Replace brake disc.</li> <li>- Refit or replace pads.</li> </ul>
Unstable ride	<ul style="list-style-type: none"> <li>- Steering shaft nut too tight.</li> <li>- Steering bearings worn or damaged.</li> <li>- Bent steering shaft.</li> </ul>	<ul style="list-style-type: none"> <li>- Loosen the steering nut a little.</li> <li>- Replace bearings.</li> <li>- Take bike to a specialist garage.</li> </ul>
Suspension too hard	<ul style="list-style-type: none"> <li>- Too much oil in fork.</li> <li>- Oil in fork too dense.</li> <li>- Twisted or bent fork.</li> <li>- Excessive tyre pressure.</li> <li>- Rear shock absorber badly adjusted.</li> </ul>	<ul style="list-style-type: none"> <li>- Remove excess oil.</li> <li>- Replace oil with correct density.</li> <li>- Take bike to a specialist garage.</li> <li>- Adjust tyre pressure.</li> <li>- Adjust rear shock absorber.</li> </ul>

PROBLEM	POSSIBLE CAUSES	STEPS TO TAKE
Suspension too soft	<ul style="list-style-type: none"> <li>- Low oil level in fork.</li> <li>- Oil with excessively low density.</li> <li>- Rear shock absorber badly adjusted.</li> </ul>	<ul style="list-style-type: none"> <li>- Add the right oil to the specified level.</li> <li>- Replace oil with correct density.</li> <li>- Adjust rear shock absorber.</li> </ul>
Handlebar vibration	<ul style="list-style-type: none"> <li>- Worn tyre, swinging arm or bearings worn.</li> <li>- Rim off-centre.</li> <li>- Badly aligned wheel.</li> <li>- Steering shafts, handlebar supports or fasteners with play.</li> </ul>	<ul style="list-style-type: none"> <li>- Take bike to a specialist garage.</li> <li>- Take bike to a specialist garage.</li> <li>- Take bike to a specialist garage.</li> <li>- Tighten nuts and fasteners to specified torque.</li> </ul>
Brakes working badly	<ul style="list-style-type: none"> <li>- Pads worn</li> <li>- Discs worn.</li> <li>- Loss of brake fluid.</li> <li>- Brake fluid in bad condition.</li> <li>- Master cylinder piston worn.</li> <li>- System incorrectly adjusted.</li> </ul>	<ul style="list-style-type: none"> <li>- Change pads</li> <li>- Change discs.</li> <li>- Check circuits. Replace leaking parts and top up fluid to the correct level.</li> <li>- Remove brake fluid circuit and replace with fresh fluid of the right type.</li> <li>- Replace master cylinder piston.</li> <li>- Adjust brakes.</li> </ul>
Fusing bulbs	<ul style="list-style-type: none"> <li>- Voltage regulator problems.</li> </ul>	<ul style="list-style-type: none"> <li>- Check connections. Check voltage regulator and fuses.</li> </ul>

44 - Recommended products

RECOMMENDED PRODUCTS

TRS Motorcycles recommends the use of NILS lubricants and maintenance products.





## Warning Symbols

- 

**SAFETY/ATTENTION**  
This symbol refers to points which, if ignored, could lead to physical danger for the user.
- 

**VEHICLE PROPER ASSEMBLY**  
This symbol refers to points which, if ignored, could lead to some kind of damage to your motorcycle. Non-observance of these warnings could render your motorcycle warranty void.
- 

**DANGER DUE TO THE PRESENCE OF FLAMMABLE LIQUID**  
Carefully read the use and maintenance manual.
- 

**OBLIGATION TO USE PROTECTIVE CLOTHING AND ACCESSORIES**  
The use of the vehicle is subordinate to the employment of clothing and accessories of protection (safety shoes).  
To use the vehicle it is mandatory to wear protective clothing and accessories.
- 

**PROTECTIVE GLOVES MUST BE USED**  
To take the action described, the use of protective gloves is obligatory.
- 

**THE USE OF OPEN FIRES OR FORMS OF UNCONTROLLED SOURCES OF IGNITION IS PROHIBITED**
- 

**SMOKING IS PROHIBITED**
- 

**THE USE OF MOBILE PHONES IS PROHIBITED**
- 

**DANGER DUE TO THE PRESENCE OF CORROSIVE SUBSTANCES**  
The liquids marked with this symbol are very corrosive: Handle with extreme care.
- 

**DANGER OF POISONING**